

**RL**  
 us  
 c  
 E301099

**SÉRIE 2500**  
 FEUILLE D'INSTALLATION  
**2500 SERIES**  
 INSTALLATION SHEET

**1. Installation**

1. Visser les braquettes à la surface désirée.

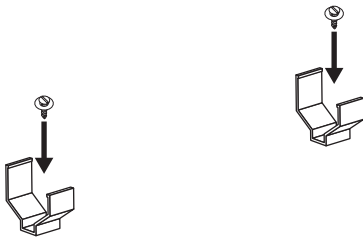

2. Insérer la barre profilée dans les braquettes.



Safe, Fast and Easy to install with the ELED POWER  
 Installation simple et rapide avec le système de connexion  
 ELED POWER



**1. Installation**

1. Screw the brackets to the desired surface.

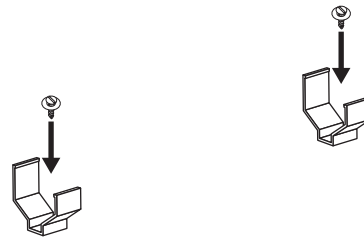

2. Clip the profiled bar into the brackets.

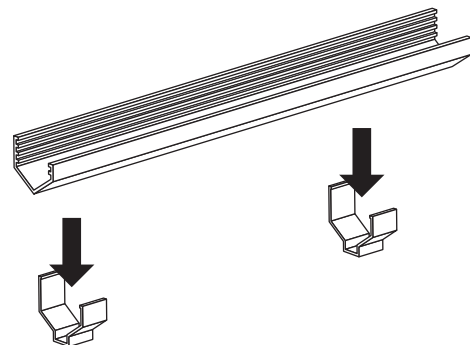

## 1. Installation

3. Glisser le rail à l'intérieur de la barre profilée.

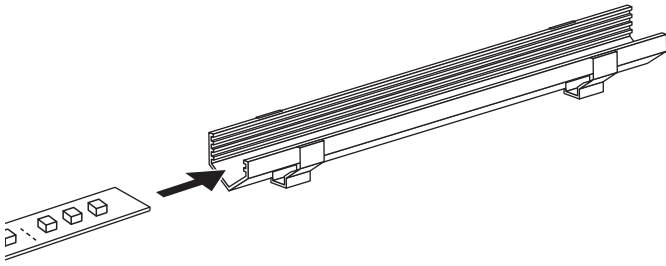

5. Glisser les embouts en place.

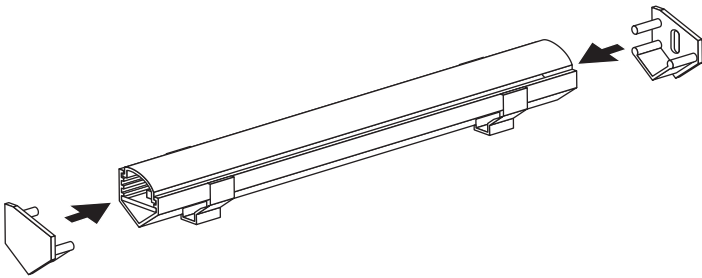

## 1. Installation

3. Slide the rail into the profiled bar.

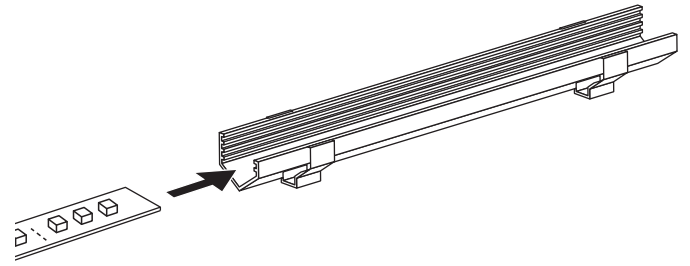

5. Slide the encaps into place.

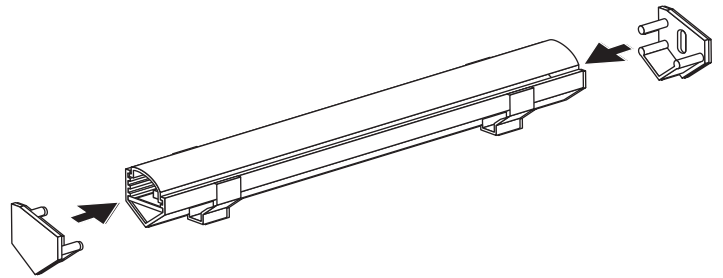

### Mise en garde

1. Utiliser seulement des composants Certifiées Classe 2 n'excédant pas 30VCC ou 15VAC lors d'une installation dans un endroit mouillé ou 60VCC ou 42.4V ca maximum lors d'une installation dans un endroit sec ou humide.
2. Ne pas dépasser 5 ampères pour respecter les normes classe 2.

CLASSE  
2

100W  
MAX

4 AMP MAX  
↓ 24V

5 AMP MAX  
↓ 12V

### Warning

1. Use only Class 2 rated components not exceeding 30VDC or 15VAC when installing the outline lighting in wet locations or 60VDC or 42.4V peak ac when installing the outline lighting in a dry or damp location.
2. Do not go over 5 amps to match class 2 requirements.

CLASS  
2

100W  
MAX

4 AMP MAX  
↓ 24V

5 AMP MAX  
↓ 12V